

# ***MOBILE DISPENSING UNIT***



***MODEL : NTR/07***

## FEATURES

- Accuracy:  $\pm 0.1\%$  (output volume  $> 99.9\%$  of input volume).
- Positive displacement meter.
- Repeatability 100% .
- Electronic register unit with 6 digit LCD display .
- There is a inbuilt printer by which one can print the bill after each delivery.
- The rate of the fuel can be set very easily with the help of the key pad .
- The clock can be set in 24h format with the help of the key pad .
- The volume(ml) of the fuel can be set before which the machine goes to low flow mode from high flow mode .
- E totaliser is available for the cumulative figure of total delivery .
- The company name , address , contact number, employee id , nozzle id ,fuel type , density of the fuel can be set with help of key pad which can be printed on the bill .
  
- Scope of Access Control via Keypad.
- Very easy installation & maintenance.
- Can reach customer door steps .
- Prompt after sale service.
- Measures, monitors the exact volume of liquid specially petroleum products like LDO , HSD , KEROSENE , FURNACE OIL , BIO DIESEL etc. Functions equally in static or mobile conditions in urban , suburban & rural areas .
- The soft copy of the bill can also be sent through SMS to the customer.
- Scope of downloading transaction details from internally memory in USB Drive. (ADD-ONS NEEDED )
- Scope of Remote Access Control. (ADD-ONS NEEDED )
- Scope of communicating with Remote automation (wired-RS485, wireless –GSM/GPS) . (ADD-ONS NEEDED ) .

## **SPECIFICATION**

1.	MODEL NO.	NTR/07
2.	FLOW RATE RANGE	30-90 LPM
3.	OPERATING TEMPERATURE	-5°C TO + 60°C
4.	ELECTRIC SUPPLY	12V DC
5.	LEAST COUNT	10ML
6.	DISPLAY	6 DIGITS BACK LIT LCD
7.	PRESET FACILITY	BOTH LITRE & RUPEES
8.	NOZZLE	AUTO CUT OFF NOZZLE
9.	TOTALISER	BOTH MECHANICAL & ELECTRONIC
10.	APPROVALS	ACCURACY : DEPARTMENT OF LEGAL METROLOGY, GOV. OF INDIA  SAFETY : PESO ( INDIA )

# **DIFFERENT PARTS :**

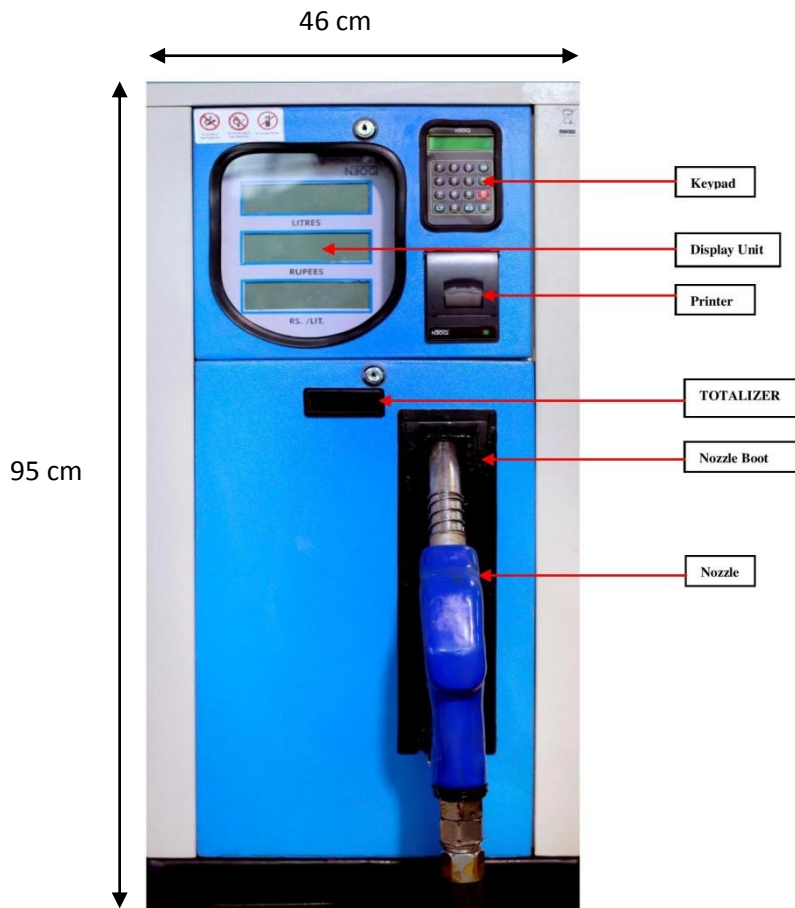

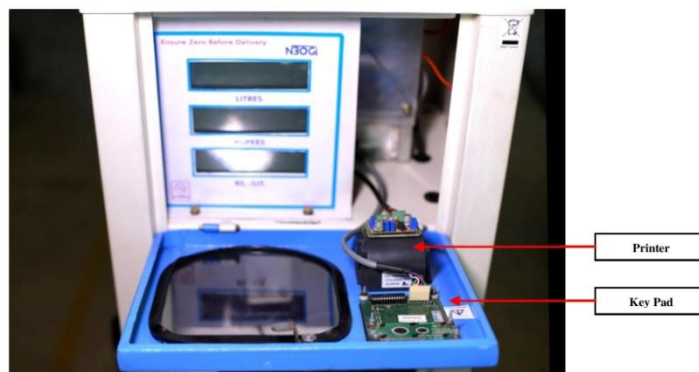
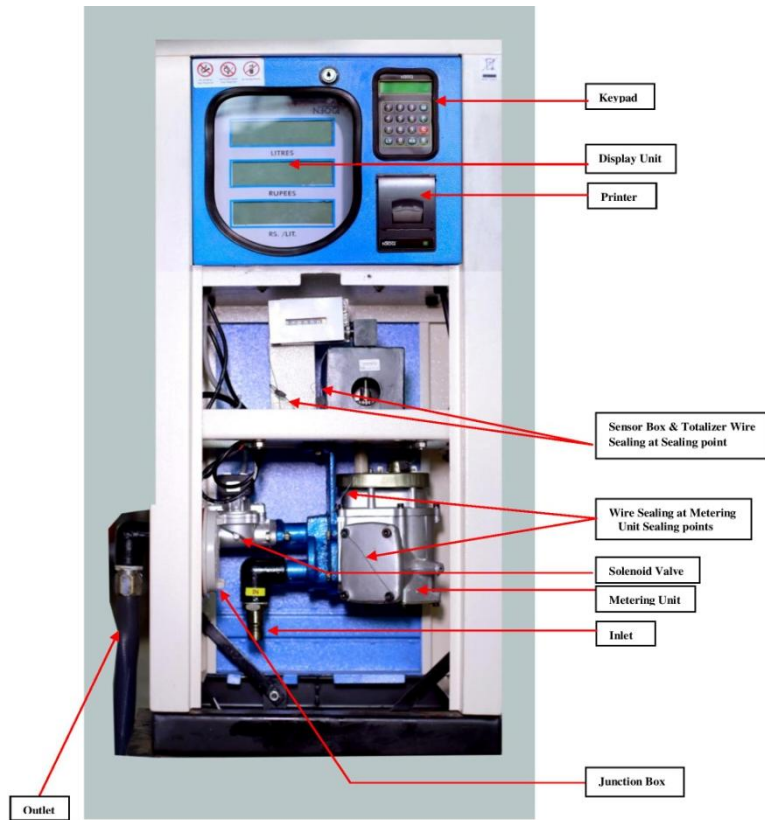

## ***LOCATION OF DISPENSER ON TRUCK :***

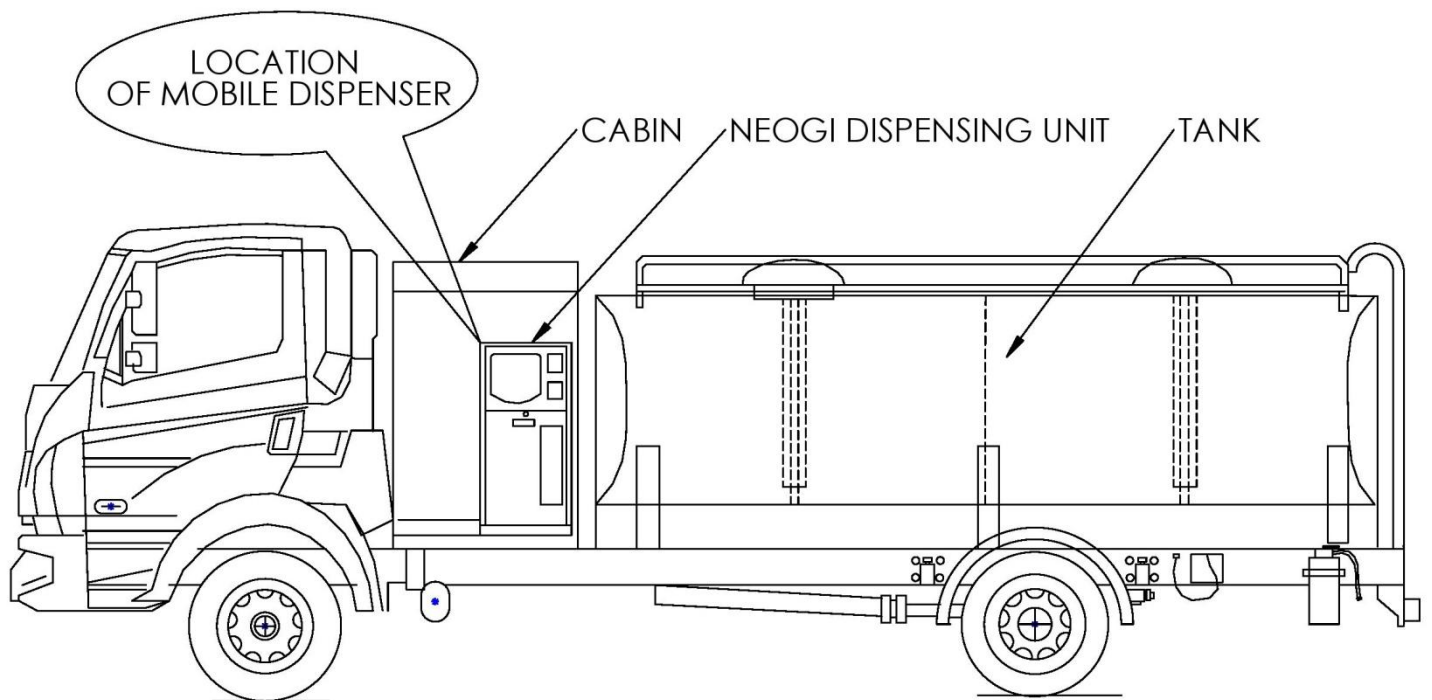

NOTE: PESO APPROVED TRUCK TO BE USED

## ***IMPORTANT SAFETY INFORMATION :***

### **Total Electrical Shut-Off Before Access:**

**Any procedure that requires access to electrical components or the electronics of the dispenser requires total electrical shut off of that unit.**

### **Emergency Switch Operation.**

**A prominent push switch is provided on the Pump/Dispenser for emergency stop.**

**Emergency switch is to be used in case of any emergency requiring to stop the complete operation of the dispenser. If anyone pressed emergency switch dispenser will stop operations completely.**

**Once pressed, the emergency switch will have to be manually reset by turning the knob in the direction as indicated on the emergency switch.**

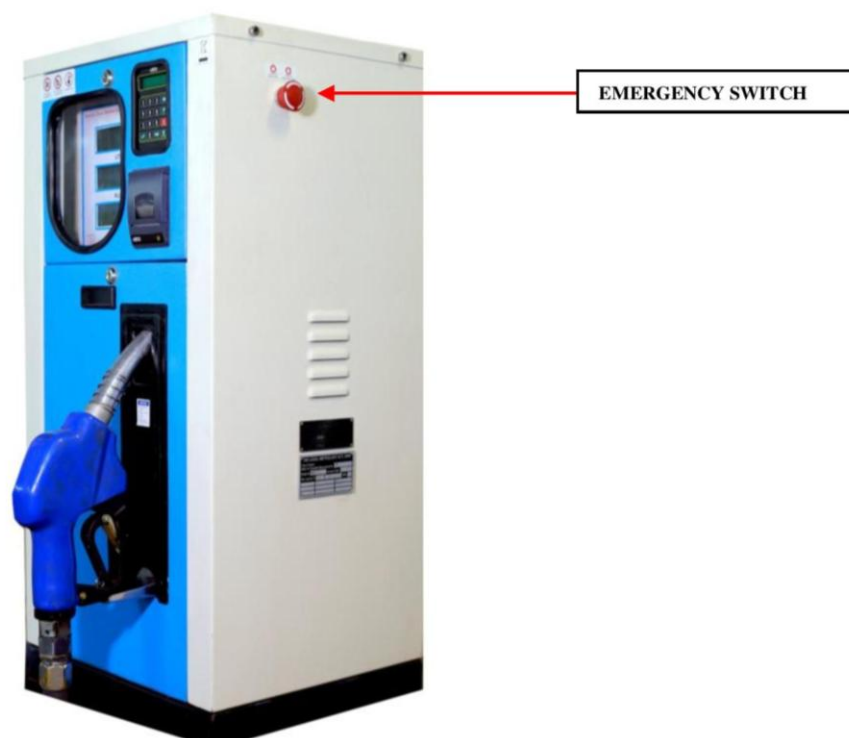

**Follow the Regulations:**

**Follow applicable regulations in your country including local requirements.**

**Replacement Parts:**

**Use only genuine NEOGI replacement parts and retrofit kits on your dispenser. Using parts other than genuine NEOGI replacement parts could create a safety hazard .**

**Meaning of Symbol & Warnings :**



Caution



No Smoking near Dispenser



No Fire/No Spark near Dispenser



No Mobile Phone

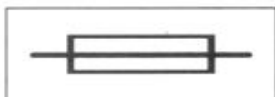

Resettable Fuses



Alternating Current

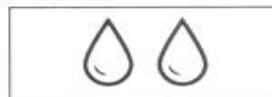

Two drops Water tight construction



Safety alert Symbol



Nature of Supply : AC only:  
rated mains frequency



Nature of Supply : DC only



Switch On / Off



"WEEE" Symbol

**Instruction about the "WEEE" symbol.**

This product should not be disposed with other commercial wastes at the end of its working life. Please separate this from other types of wastes and recycle or dispose it responsibly to promote the sustainable reuse of material resources. This will prevent possible harm to the environment or human health from uncontrolled waste disposal.

This product should not be mixed with other commercial wastes of disposal.

• V -Volts

• Hz -hertz

• W -watts

• kW-kilo-watts



## ***CAUTION :***



**ENSURE VALID FIRE EXTINGUISHER IS AVAILABLE NEAR THE WORKING AREA.**



**ENSURE PROPER EARTHING IS PROVIDED TO FUEL DISPENSER**



**DO NOT OPEN WHEN ENERGIZED.**

**Please contact Neogi Technologies & Research Pvt. Ltd. for availability of genuine spare parts and services. Maintenance carried out by untrained personnel may lead to trouble or accidents. Do not modify the dispensing unit.**